

# ELECTROBOMBA CENTRÍFUGA MED. PRESIÓN

Serie: IB

1-15 HP / 1750 y 3450 RPM

Succión: 2" - 3" NPT

Descarga: 1½" - 2½" NPT



▶ Con impulsor de acero inoxidable

## APLICACIONES

- ▶ Sistemas hidroneumáticos
- ▶ Transferencia de agua
- ▶ Sistemas de enfriamiento
- ▶ Alto caudal / mediana presión

## VOLUTA

Hierro gris ASTM A-48 clase 30

## TEMPERATURA DEL LÍQUIDO

71 °C (160 °F) máx.

## ACOPLAMIENTO

Hierro gris ASTM A-48 clase 30

## IMPULSOR

**Diseño:** cerrado, balanceado dinámicamente.

**Material:** acero inoxidable 304

## SELLO MECÁNICO

**Diseño:** mecánico, autolubricado.

**Material:** cerámica en parte estacionaria, anillo de carbón y sello de exclusión en parte rotatoria. Elastómero de Buna-N y resorte de acero inoxidable.

## MANGUITO

Acero inoxidable

## EMPAQUES

Forma "O" de Buna-N

## MOTOR

Motores eléctricos NEMA totalmente cerrados con ventilación externa o abiertos a prueba de goteo, de alta calidad, diseñados y desarrollados conforme a los estándares para aplicaciones de bombeo industrial y comercial.

- ▶ 1 y 3 fases, 60 Hz
- ▶ Potencia: 1 a 15 HP
- ▶ 1750 y 3450 RPM
- ▶ Armazones: 143JM a 254JM

## TORNILLERÍA

Acero al carbón

## PINTURA

Esmalte de secado al aire, a base de agua.

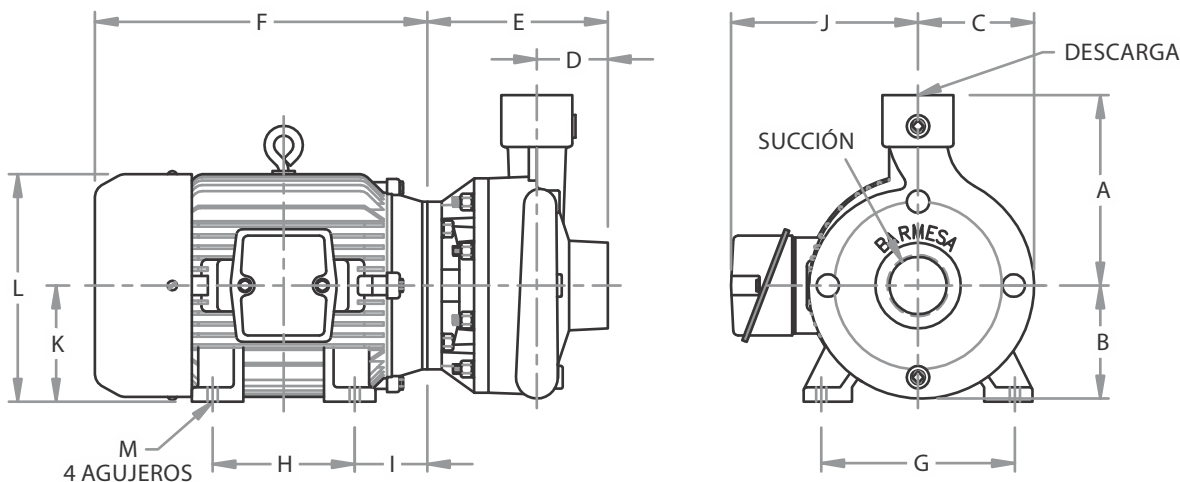

\*Dibujo representativo

**ODP**

MODELO	TAMAÑO	HP	FASES	RPM	ARMAZÓN	A	B	C	D	E	F	G	H	I	J	K	L	M
IB1½-5-2	2" x 1½"	5	3	3450	182 JM	7.38	4.38	4.5	2.75	7	11.81	7.5	4.5	3.63	6.88	4.5	8.5	0.41
IB1½-5-2-1		5	1	3450	184 JM								5.5					
IB1½-7.5-2		7.5	3	3450	184 JM								5.5					
IB2-5-2	2½" x 2"	5	3	3450	182 JM	7.75	4.63	4.81	2.88	7.13	11.81	7.5	4.5	3.63	6.88	4.5	8.5	0.41
IB2-5-2-1		5	1	3450	184 JM								5.5					
IB2-7.5-2		7.5	3	3450	184 JM								5.5					
IB2-10-2		10	3	3450	213 JM								7.25					
IB2½-5-2	3" x 2½"	5	3	3450	182 JM	8.38	5.13	5.25	3.5	7.63	11.81	7.5	4.5	3.63	6.88	4.5	8.5	0.41
IB2½-5-2-1		5	1	3500	184 JM								5.5					
IB2½-7.5-2		7.5	3	3450	184 JM								5.5					
IB2½-10-2		10	3	3450	213 JM								7.75					
IB2½-15-2		15	3	3450	215 JM								5.5	4.25	7.6	5.25	9.96	

**TEFC**

MODELO	TAMAÑO	HP	FASES	RPM	ARMAZÓN	A	B	C	D	E	F	G	H	I	J	K	L	M	
IB1½-1-4	2" x 1½"	1	3	1750	-	7.38	4.38	4.5	2.75	7	-	-	-	-	-	-	-	-	
IB1½-2-2		2	3	3450	145 JM						10	5.5	4	2.09	6.13	3.5	7.31	0.34	
IB1½-3-2		3	3	3450	182 JM						13.56	7.5	4.5	3.5	7.5	4.5	9.28	0.41	
IB1½-3-2-1		3	1	3450	-						-	-	-	-	-	-	-	-	
IB1½-5-2		5	3	3450	184 JM						13.56	7.5	5.5	3.5	7.5	4.5	9.28	0.41	
IB1½-5-2-1		5	1	3450	-						-	-	-	-	-	-	-	-	
IB1½-7.5-2		7.5	3	3450	213 JM						-	-	-	-	-	-	-	-	
IB1½-7.5-2-1		7.5	1	3450	213 JM						7.13	15.6	8.5	5.5	4.25	8.25	5.25	10.3	0.44
IB2-1.5-4	2½" x 2"	1.5	3	1750	-	7.75	4.63	4.81	2.88	7.13	-	-	-	-	-	-	-	-	
IB2-2-2		2	3	3450	143 JM						10	5.5	4	2.09	6.13	3.5	7.31	0.34	
IB2-3-2		3	3	3450	182 JM						13.6	7.5	4.5	3.5	7.5	4.5	9.28	0.41	
IB2-3-2-1		3	1	3450	-						-	-	-	-	-	-	-	-	
IB2-5-2		5	3	3450	184 JM						13.6	7.5	5.5	3.5	7.5	4.5	9.28	0.41	
IB2-5-2-1		5	1	3450	-						-	-	-	-	-	-	-	-	
IB2-7.5-2		7.5	3	3450	213 JM						7.25	15.6	8.5	5.5	4.25	8.25	5.25	10.25	0.44
IB2-7.5-2-1		7.5	1	3450	-						-	-	-	-	-	-	-	-	
IB2-10-2	10	3	3450	215 JM	7.25	17.13	8.5	7	4.25	8.25	5.25	10.25	0.44						
IB2½-2-4	3" x 2½"	2	3	1750	145 JM	8.38	5.13	5.25	3.25	7.63	10	5.5	4	2.09	6.13	3.5	7.31	0.34	
IB2½-5-2		5	3	3450	184 JM						13.56	7.5	5.5	3.5	7.50	4.5	9.28	0.41	
IB2½-5-2-1		5	1	3450	-						-	-	-	-	-	-	-	-	
IB2½-7.5-2		7.5	3	3450	213 JM						15.63	8.5	5.5	4.25	8.25	5.25	10.25	0.44	
IB2½-10-2		10	3	3450	215 JM						17.13	8.5	7	4.25	8.25	5.25	10.25	0.44	
IB2½-15-2		15	3	3450	254 JM						20.13	10	8.25	4.75	9.94	6.25	12.94	0.53	

Todas las dimensiones aparecen en pulgadas, y pueden variar dependiendo del fabricante del motor.

\* Consultar dimensiones (-) con su distribuidor Barmesa.

**¡IMPORTANTE!**

1. No utilice la bomba para bombear líquidos explosivos ni corrosivos.
2. Esta bomba no está aprobada para ser utilizada en piscinas, instalaciones recreativas, o cualquier aplicación donde el contacto humano con la bomba sea común.

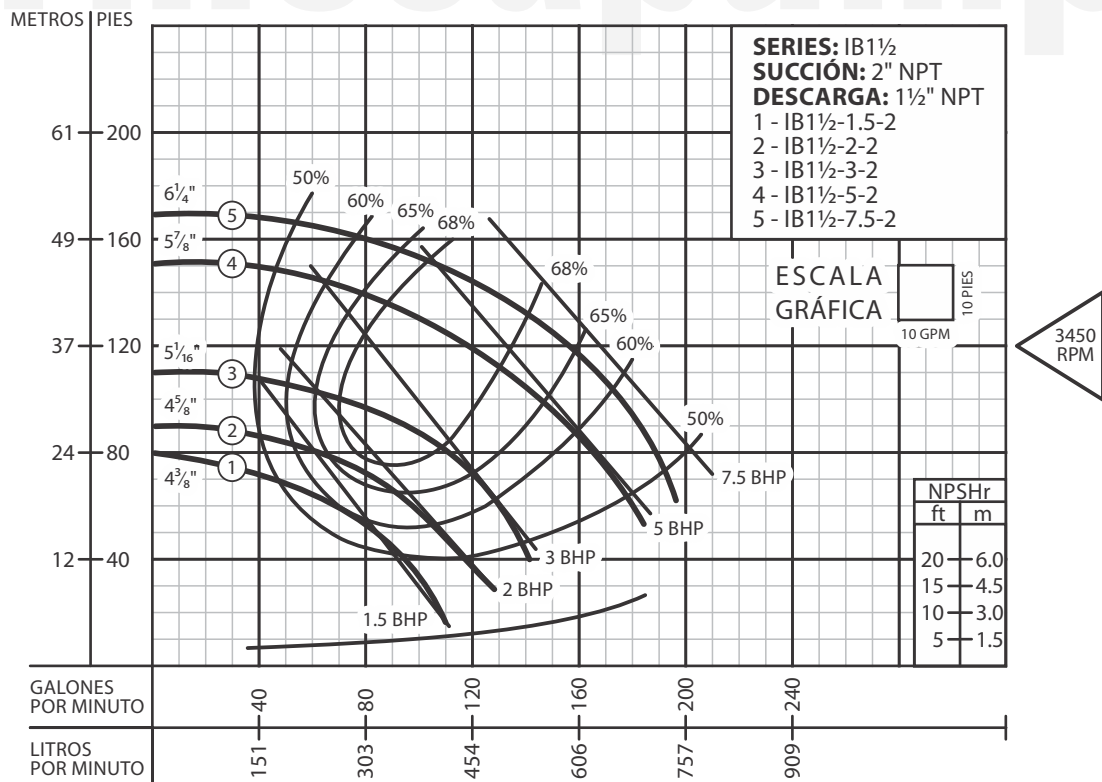
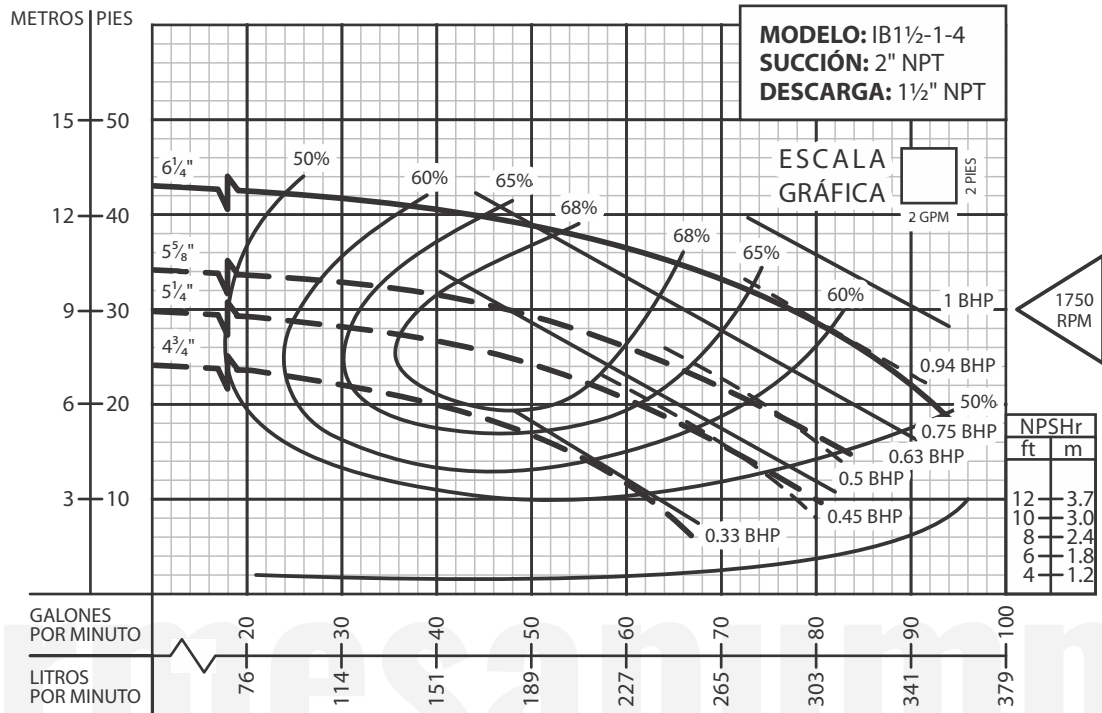

Prueba realizada con agua, gravedad específica 1.0 @ 20 °C (68 °F); otros líquidos pueden variar el rendimiento.

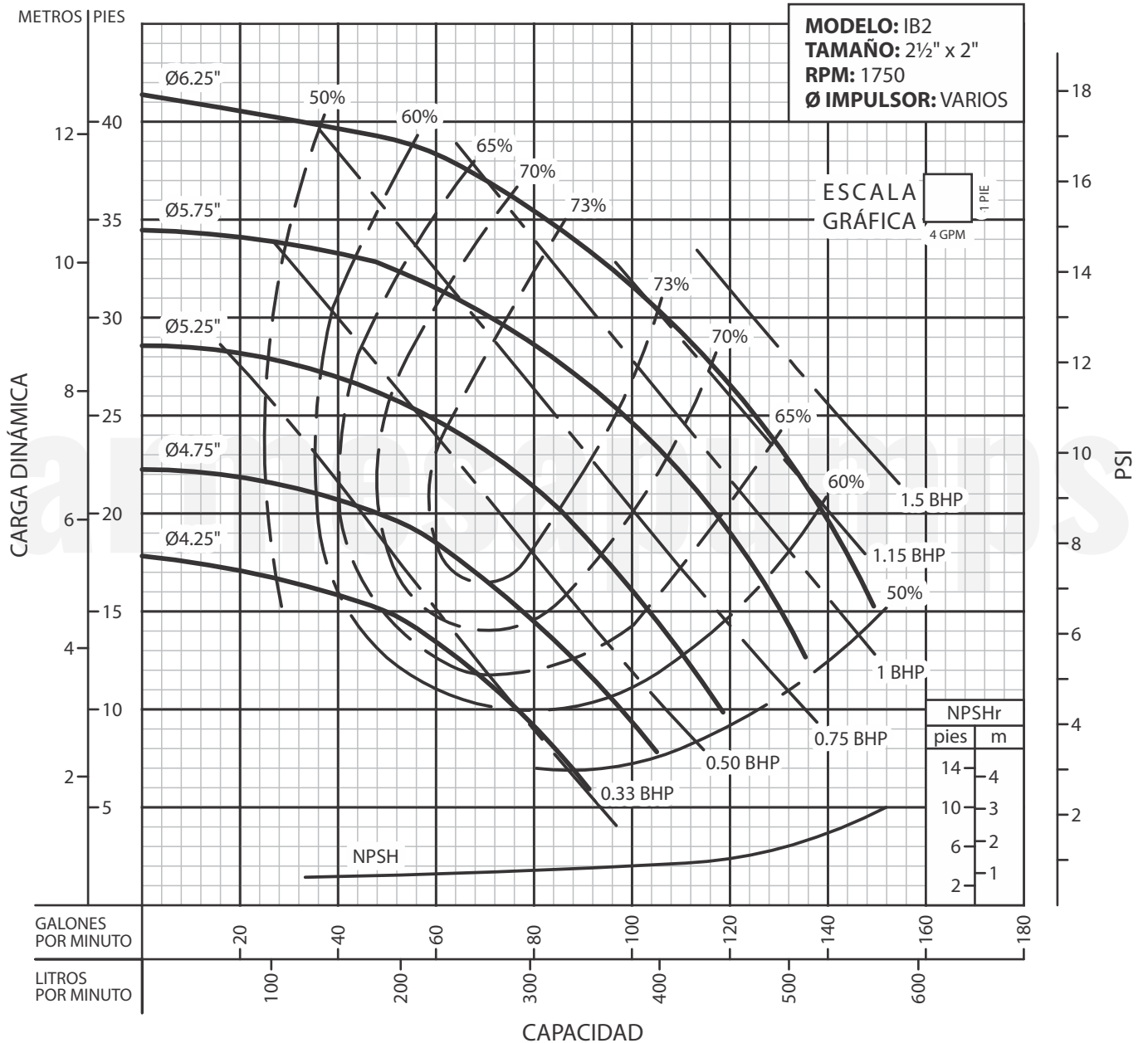

Prueba realizada con agua, gravedad específica 1.0 @ 20 °C (68 °F); otros líquidos pueden variar el rendimiento.

# CURVA DE RENDIMIENTO

Electrobomba Centrífuga

Mediana Presión

Serie: IB2 y 2½

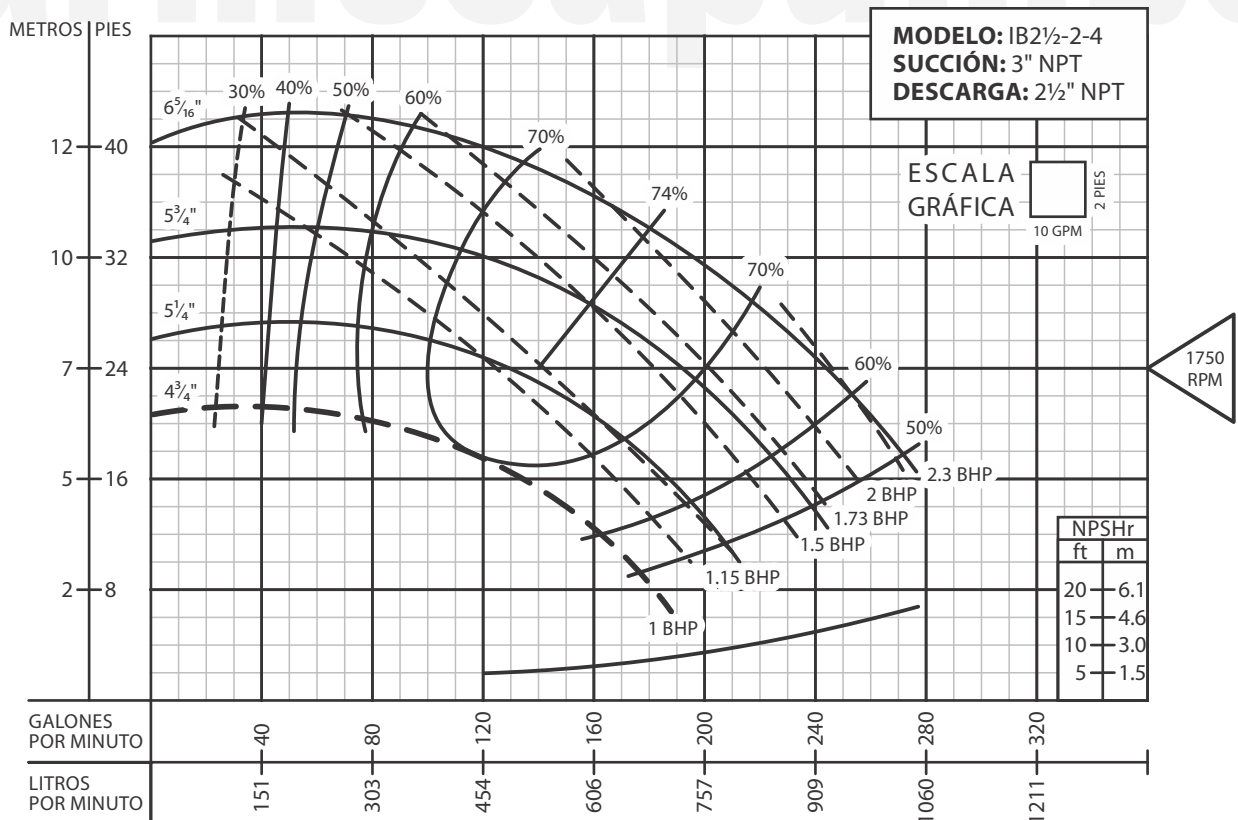
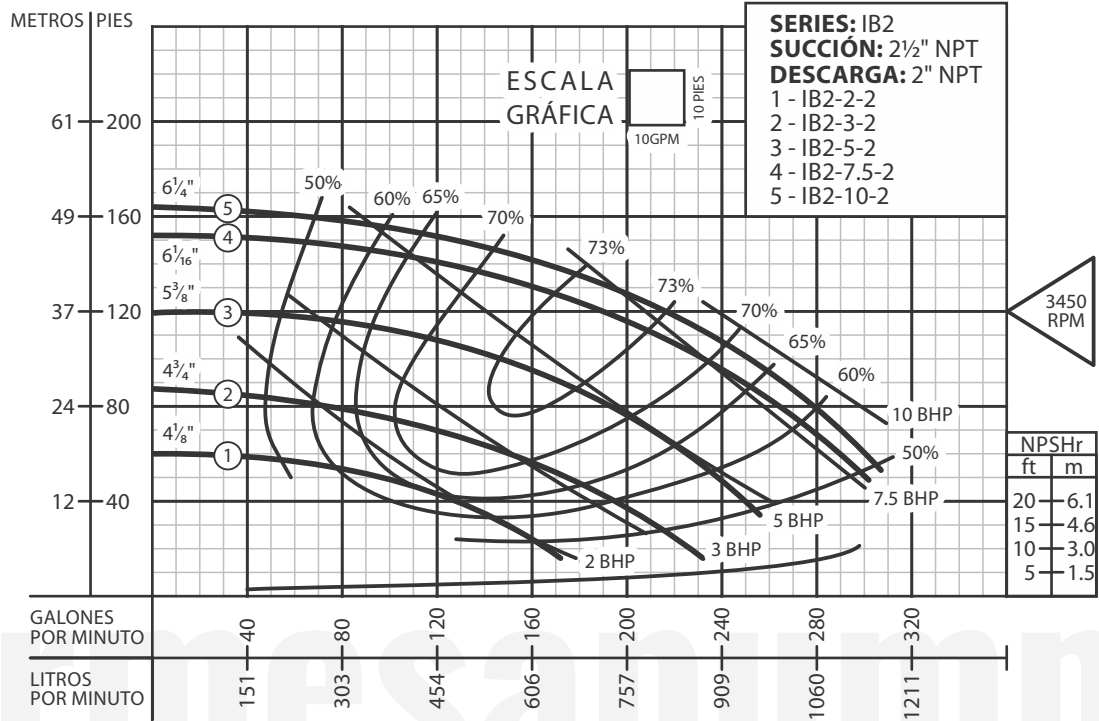

Prueba realizada con agua, gravedad específica 1.0 @ 20 °C (68 °F); otros líquidos pueden variar el rendimiento.

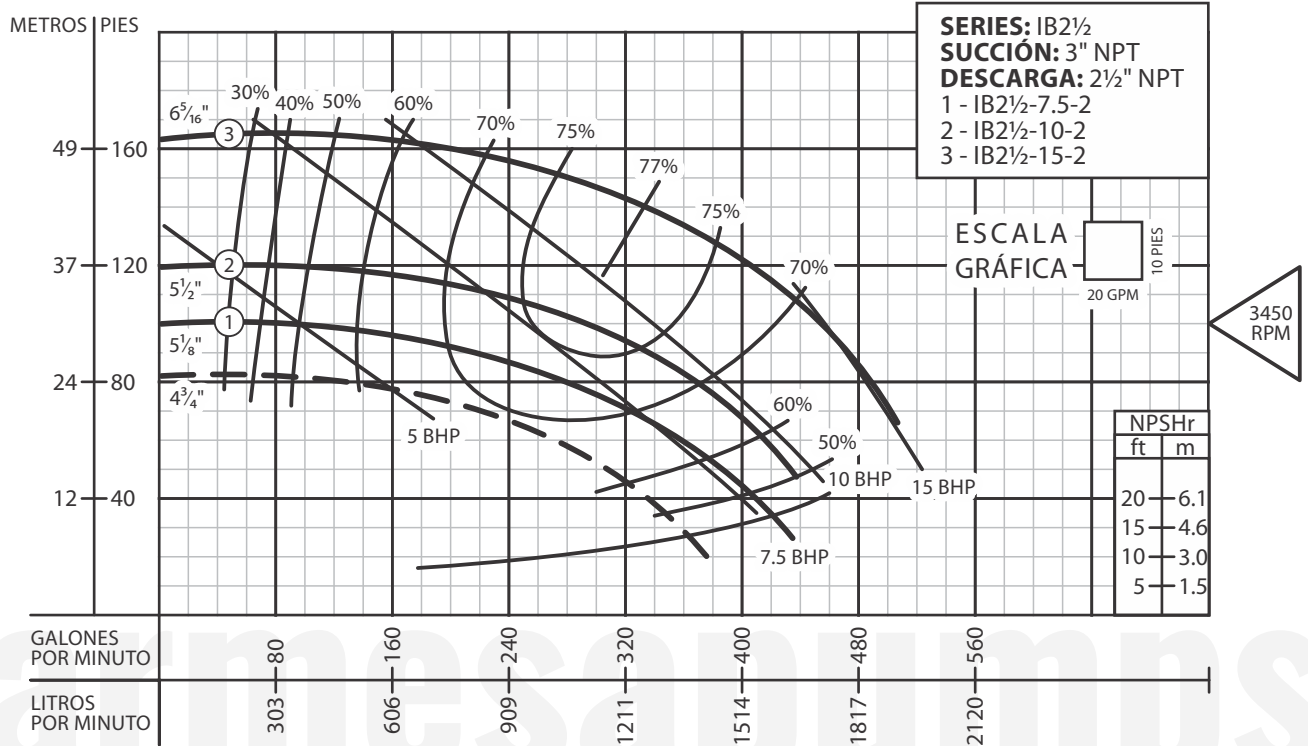

Prueba realizada con agua, gravedad específica 1.0 @ 20 °C (68 °F); otros líquidos pueden variar el rendimiento.